

ECLIPSE PDD/PDDI

(Pendant Direct/Pendant Direct-Indirect)

- ECLIPSE is a complete series of round luminaires available for surface, pendant, recessed and trimless application.
- The pendant version is offered either with only Direct or Direct/Indirect illumination.
- It consists of two models: High Power and High Efficiency.
- It is offered with a Low Glare (UGR < 20.8*) as an option in the High Power model.
- It is offered with a Low UGR (UGR < 18*) as an option in the High Efficiency model.
- Luminaire material: Aluminium.
- Cover material: PMMA
- Powder Coated: Black (RAL9005), White (RAL9003), or Grey (RAL7037) as standard.
- Custom luminaire colours also available on request.
- Low tolerances for colour temperature (MacAdam 3).
- Lumen maintenance L80/B10 50.000h
- Emergency Function capability. (3 hours, with build-in rechargeable battery).
- Indoor Use: IP40

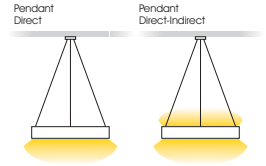

LED source efficacy up to 199lm/W (4000K)
Luminaire efficacy up to 115lm/W (4000K)

Available upon request:

- ✓ Custom luminaire colours
- ✓ Emergency version

*Glare Evaluation: X=4H / Y=8H, S=0,25H, Reflection factors: 70/50/20

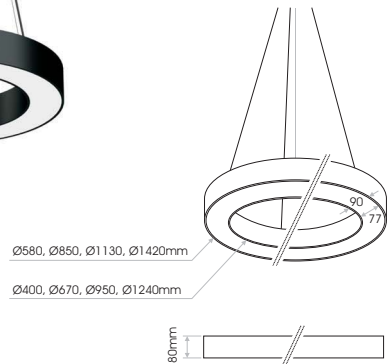



Pendant Direct

Model	Luminaire Colour*	CCT	Watt / Diameter	CRI** LED Source	CRI** LED Source	Type	Voltage	Dimming Option	Extras
ECLIPSE Pendant Direct High Power <i>(ECLIPSE PDD HP)</i>	White <i>(WH)</i>	3000K <i>(30)</i>	HIGH POWER	≥ 80 <i>(80)</i> 3000K	≥ 80 <i>(80)</i> 4000K	Opal <i>(OP)</i>	230VAC <i>(230)</i>	Non Dimmable <i>(ND)</i>	Function Standard <i>(0XX)</i> Emergency <i>(1XX)</i>
	Black <i>(BL)</i>	4000K <i>(40)</i>	46.2W / 58cm <i>(46W058)</i> 75W / 85cm <i>(75W085)</i>	6910lm 11070lm	7310lm 11740lm	Low Glare <i>(LG)***</i>		Analogue <i>(A1)</i> (1-10V)	
	Grey <i>(GR)</i>		104.5W / 113cm <i>(105W113)</i> 134.1W / 142cm <i>(134W142)</i>	15490lm 19960lm	16390lm 21100lm			DALI <i>(DL)</i> Wireless <i>(WL)</i>	Canopy - Wire Rope Length No Canopy - 1.5m <i>(X00)</i> 3m <i>(X01)</i> Cable SF - 1.5m <i>(X10)</i> 3m <i>(X11)</i> Cable RC - 1.5m <i>(X20)</i> 3m <i>(X21)</i> Cable TR - 1.5m <i>(X30)</i> 3m <i>(X31)</i> Hybrid SF - 1.5m <i>(X40)</i> 3m <i>(X41)</i> Hybrid RC - 1.5m <i>(X50)</i> 3m <i>(X51)</i> Hybrid TR - 1.5m <i>(X60)</i> 3m <i>(X61)</i>
ECLIPSE Pendant Direct High Efficiency <i>(ECLIPSE PDD HE)</i>			HIGH EFFICIENCY	≥ 80 <i>(80)</i> 3000K	≥ 80 <i>(80)</i> 4000K	Opal <i>(OP)</i>			
			17.6W / 58cm <i>(18W058)</i> 26.7W / 85cm <i>(27W085)</i> 37.2W / 113cm <i>(37W113)</i> 47.8W / 142cm <i>(48W142)</i>	2940lm 4450lm 6230lm 8020lm	3110lm 4720lm 6590lm 8480lm	Low UGR <i>(LU)***</i>			

* Custom luminaire colours available upon request.

** Available in CRI90 upon request.

*** Low Glare (UGR<20.8), Low UGR (UGR<18)

Ordering Code Example: ECLIPSE PDD HP-BL-30-105W113-80-LG-230-ND-011



Pendant Direct-Indirect



Model	Luminaire Colour*	CCT DIRECT- INDIRECT	Watt / Diameter	CRI** LED Source	CRI** LED Source	Type	Voltage	Dimming Option	Extras
ECLIPSE Pendant Direct-Indirect High Power <i>(ECLIPSE PDDI HP)</i>	White <i>(WH)</i>	3000K 3000K <i>(3030)</i>	HIGH POWER	≥ 80 <i>(80)</i> 3000K	≥ 80 <i>(80)</i> 4000K	Opal <i>(OP)</i>	230VAC <i>(230)</i>	Non Dimmable <i>(ND)</i>	Function Standard <i>(0XX)</i> Emergency <i>(1XX)</i> Canopy - Wire Rope Length No Canopy - 1.5m <i>(X00)</i> 3m <i>(X01)</i> Cable SF - 1.5m <i>(X10)</i> 3m <i>(X11)</i> Cable RC - 1.5m <i>(X20)</i> 3m <i>(X21)</i> Cable TR - 1.5m <i>(X30)</i> 3m <i>(X31)</i> Hybrid SF - 1.5m <i>(X40)</i> 3m <i>(X41)</i> Hybrid RC - 1.5m <i>(X50)</i> 3m <i>(X51)</i> Hybrid TR - 1.5m <i>(X60)</i> 3m <i>(X61)</i>
	Black <i>(BL)</i>	3000K 4000K <i>(3040)</i>		DIRECT-INDIRECT	DIRECT-INDIRECT	Low Glare <i>(LG)***</i>		Analogue <i>(A1)</i> (1-10V)	
	Grey <i>(GR)</i>	69.3W / 58cm <i>(69W058)</i>		6910lm 3535lm	7310lm 3740lm	DALI <i>(DL)</i>		Wireless <i>(WL)</i>	
	4000K 4000K <i>(4040)</i>	112.5W / 85cm <i>(113W085)</i>		11070lm 5660lm	11740lm 6000lm				
	4000K 3000K <i>(4030)</i>	156.8W / 113cm <i>(157W113)</i>		15490lm 7920lm	16390lm 8380lm				
ECLIPSE Pendant Direct-Indirect High Efficiency <i>(ECLIPSE PDDI HE)</i>			HIGH EFFICIENCY	≥ 80 <i>(80)</i> 3000K	≥ 80 <i>(80)</i> 4000K	Opal <i>(OP)</i>			
				DIRECT-INDIRECT	DIRECT-INDIRECT	Low UGR <i>(LU)***</i>			
		26.3W / 58cm <i>(26W058)</i>		2940lm 1540lm	3110lm 1628lm				
		40W / 85cm <i>(40W085)</i>		4450lm 2340lm	4720lm 2480lm				
		55.9W / 113cm <i>(56W113)</i>		6230lm 3280lm	6590lm 3470lm				
	71.7W / 142cm <i>(72W142)</i>	8020lm 4220lm	8480lm 4460lm						

- * Custom luminaire colours available upon request.
- ** Available in CRI90 upon request.
- *** Low Glare (UGR<20.8), Low UGR (UGR<18)

Ordering Code Example: ECLIPSE PDDI HP-BL-30-157W113-80-LG-230-ND-011

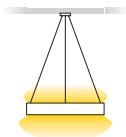



ECLIPSE PDD

HIGH POWER
HIGH EFFICIENCY

46W
18W

75W
27W

105W
37W

134W
48W

ECLIPSE PDDI

HIGH POWER
HIGH EFFICIENCY

69W
26W

113W
40W

157W
56W

201W
72W

Weight

3.63Kgs

5.48Kgs

7.42Kgs

10Kgs

Direct

HIGH POWER

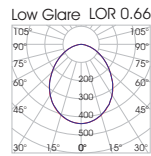
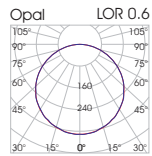

HIGH EFFICIENCY

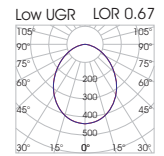
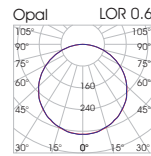

Indirect

HIGH POWER

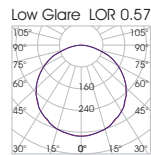
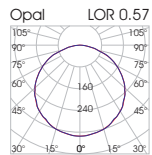

HIGH EFFICIENCY

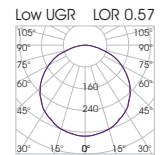
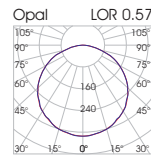

Canopies & Suspension

1. Cable SF (Surface)

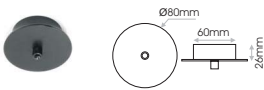

2. Cable RC (Recessed)

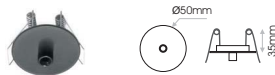

3. Cable TR (Trimless)

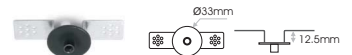

4. Hybrid SF (Surface)

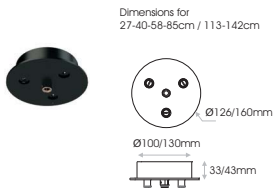

5. Hybrid RC (Recessed)

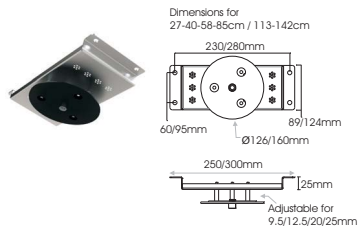

6. Hybrid TR (Trimless)

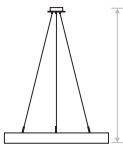
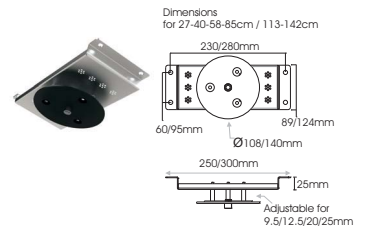

Minimum allowed ceiling-luminaire distances for Hybrid canopies

for 27cm - 35cm for 85cm - 85cm
for 40cm - 40cm for 113cm - 110cm
for 58cm - 60cm for 142cm - 160cm

For smaller distances, mount the wire ropes directly to the ceiling and use cable canopies.